

Σ 59

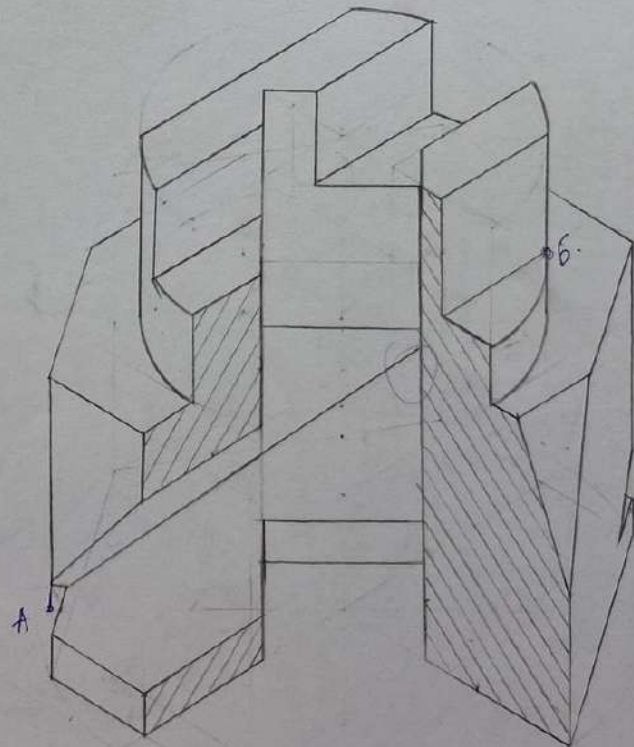

37

Аксометр. вид
Построение 06

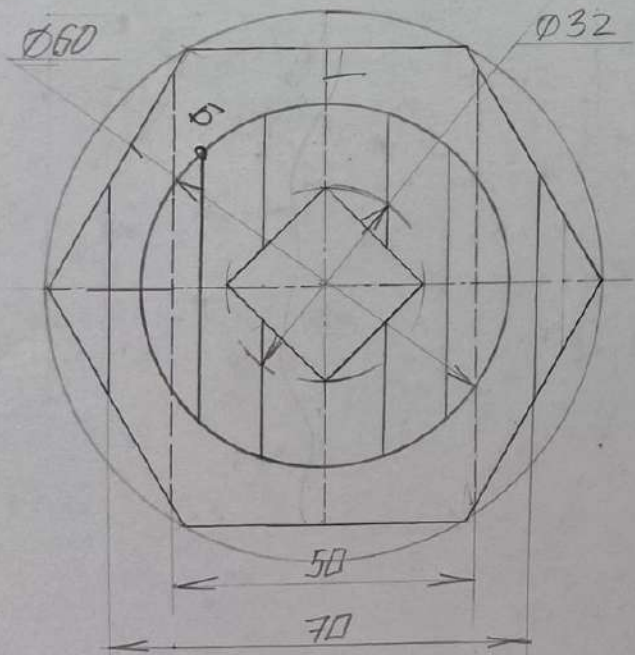
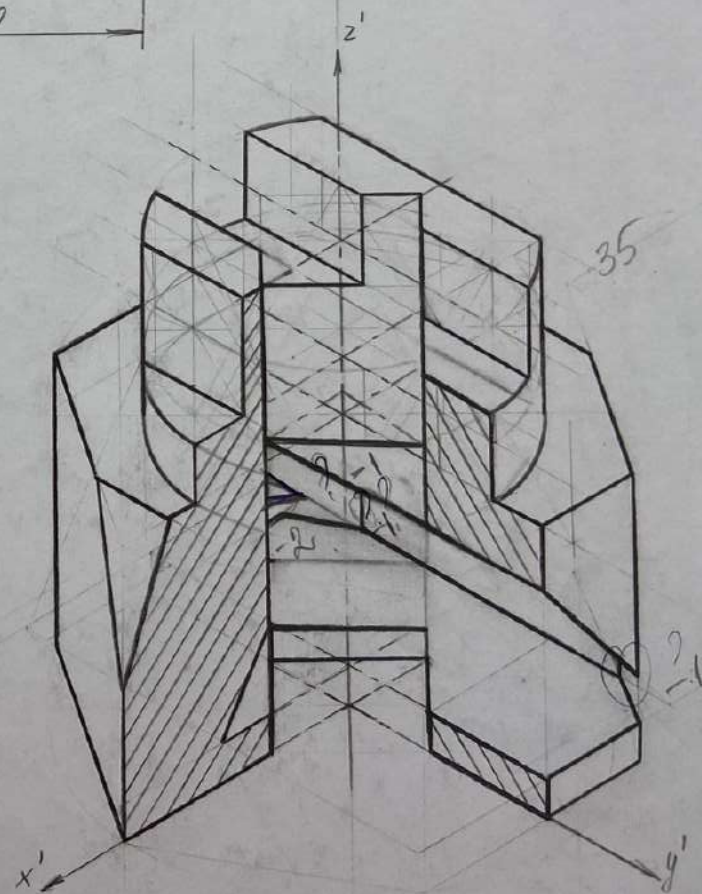
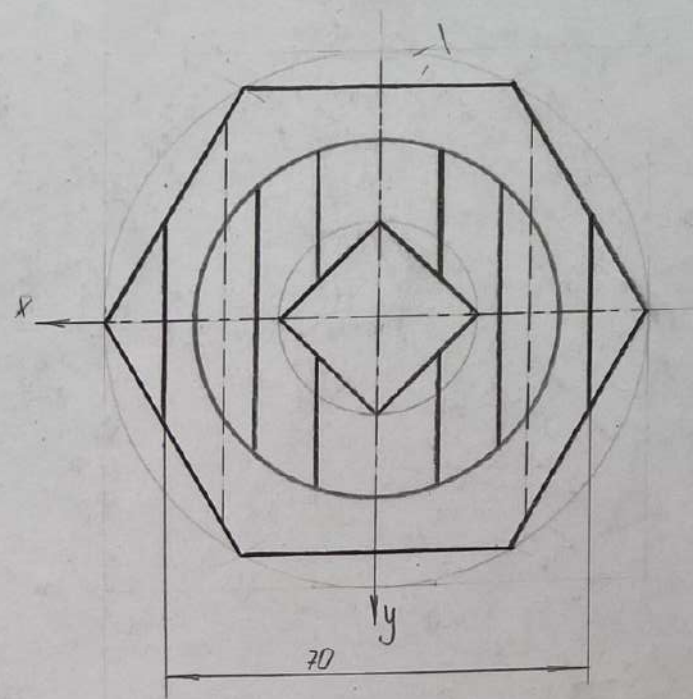
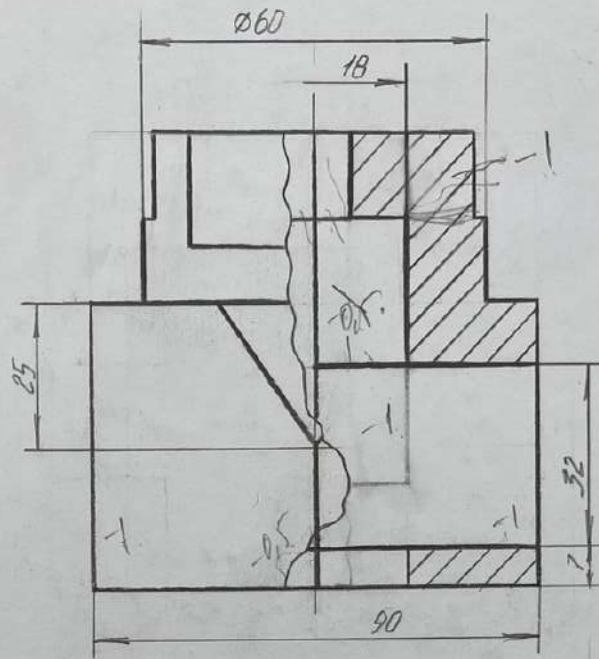
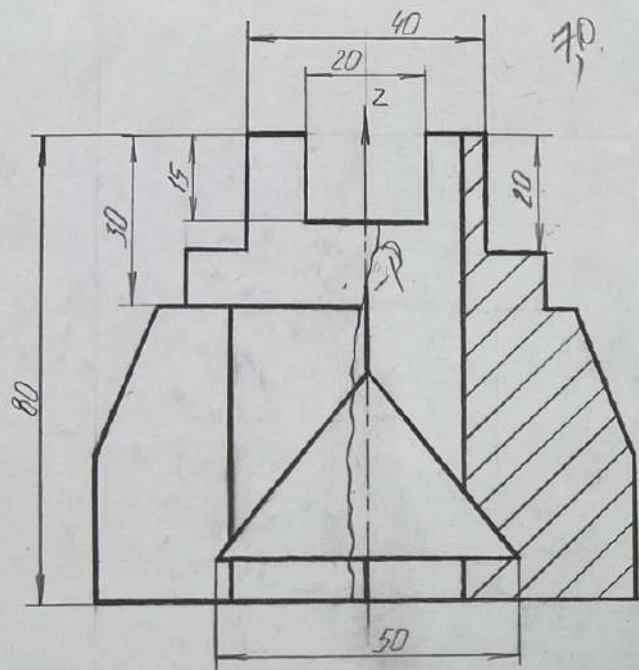

70

15

≅ 56

3

35

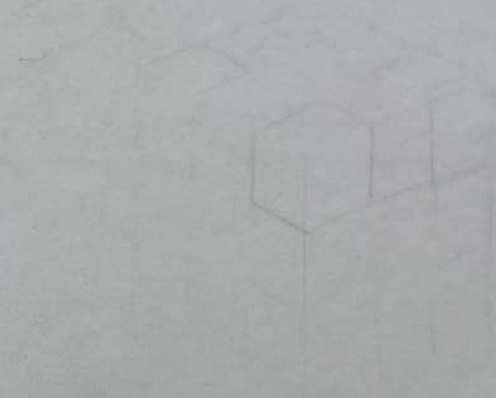
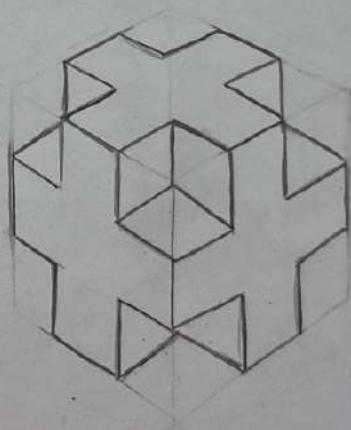
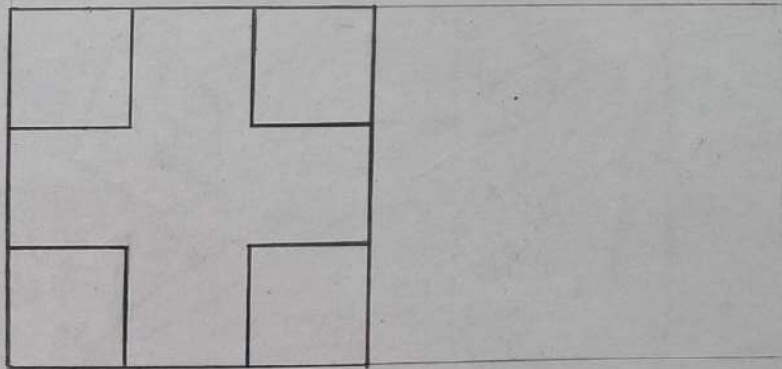
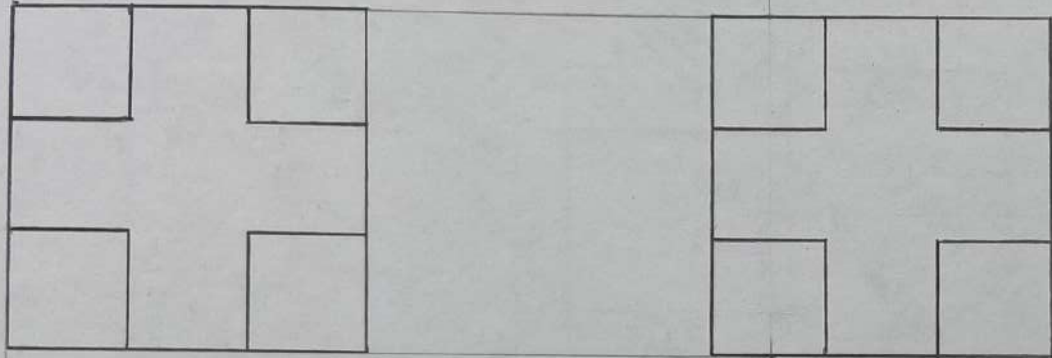

86.

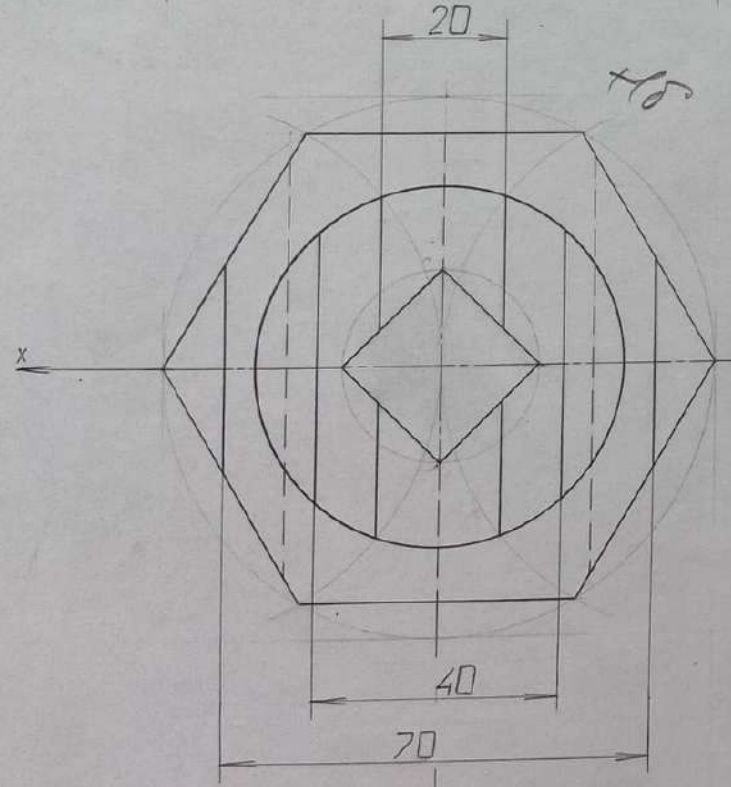
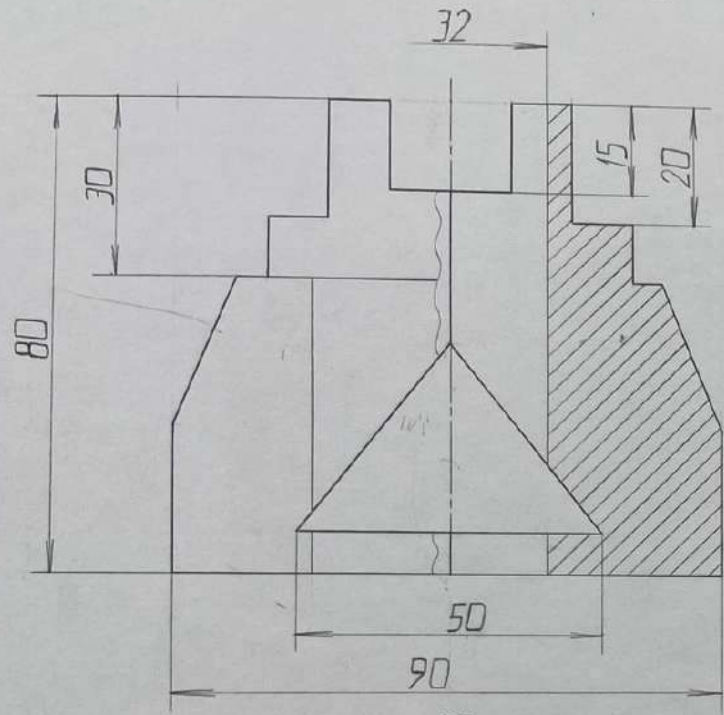

176.

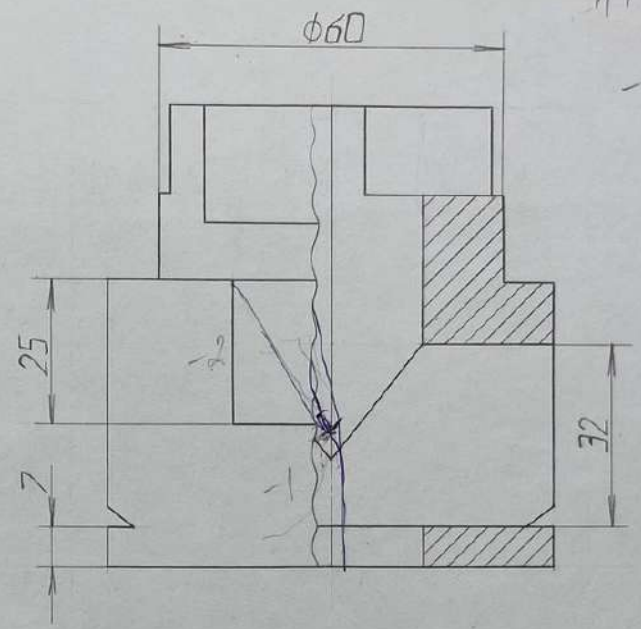

-3

$\leq 60,5$

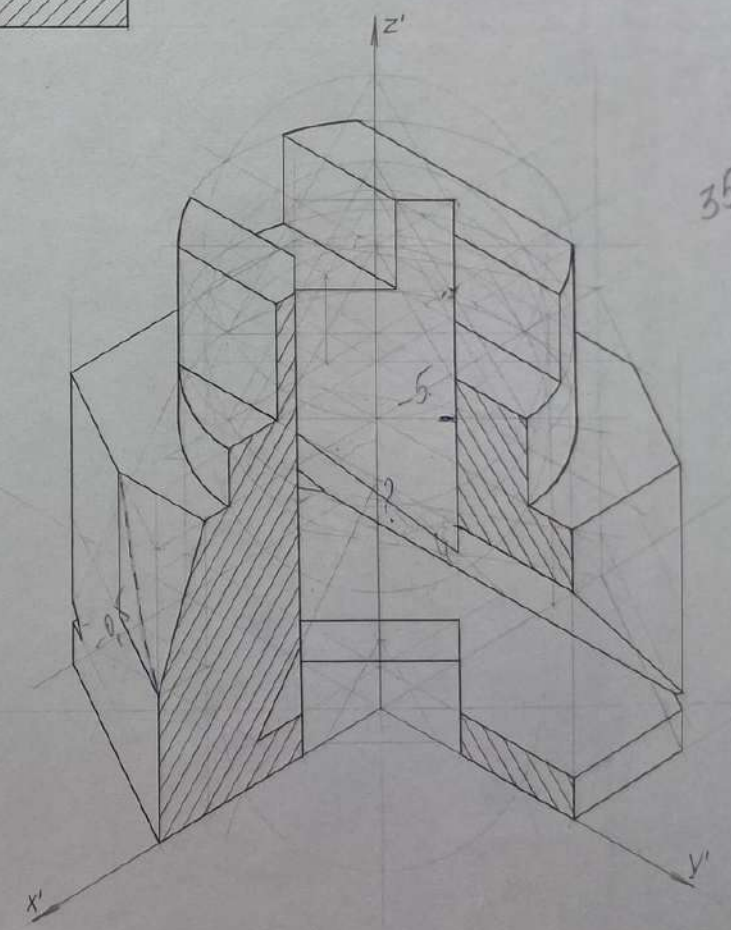

35,5

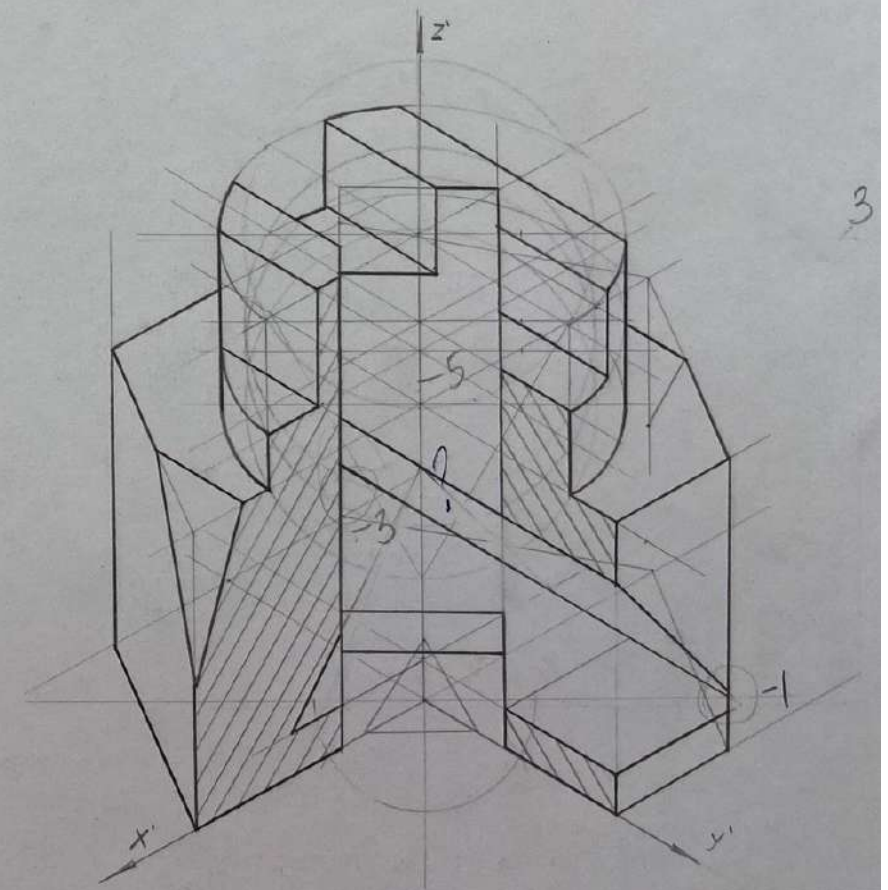
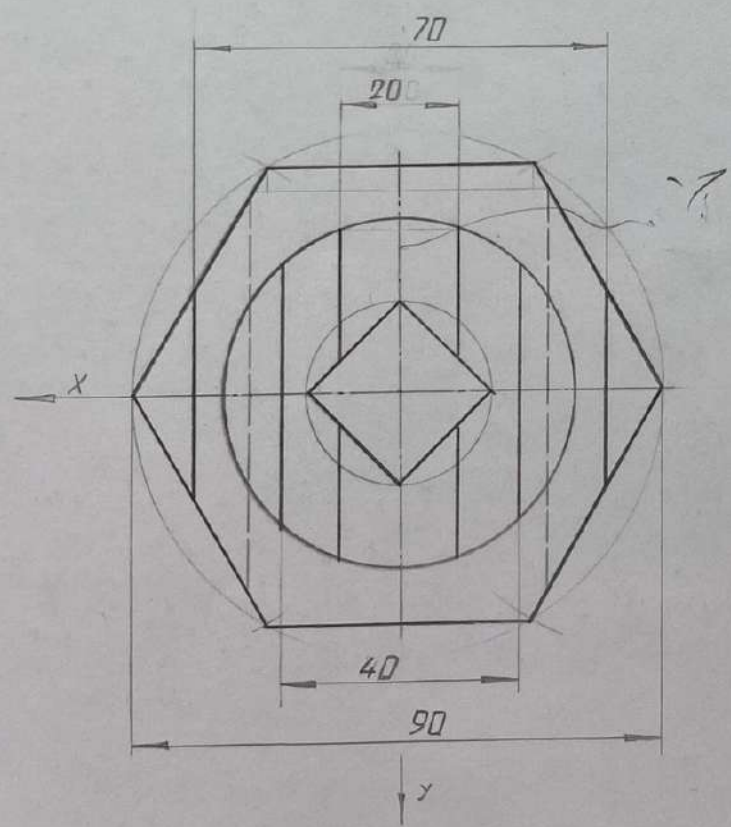
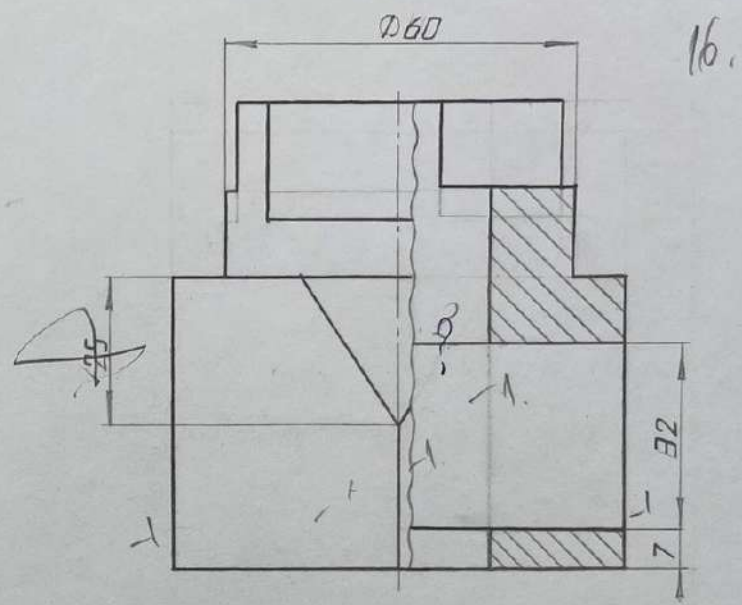
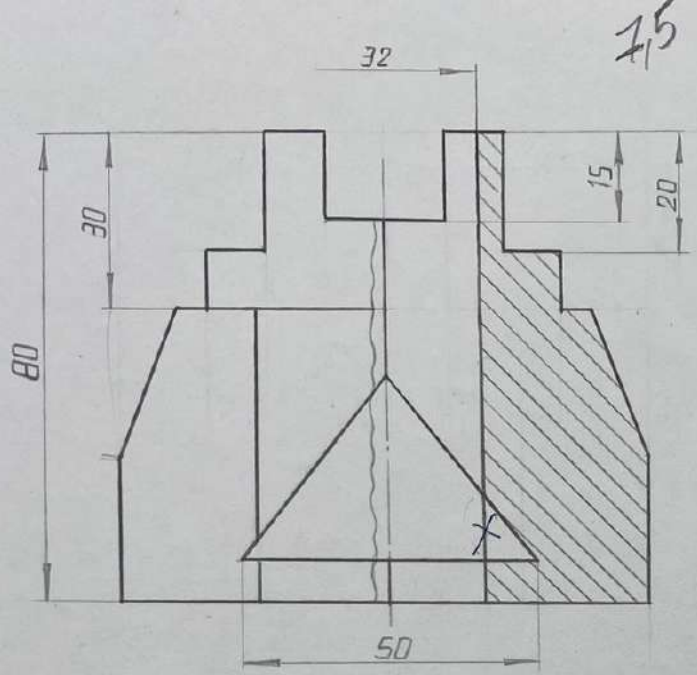

ЗОБРАЖЕНИЕ

1)

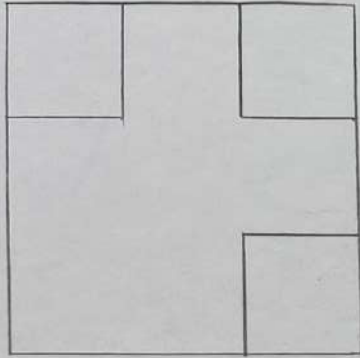

1

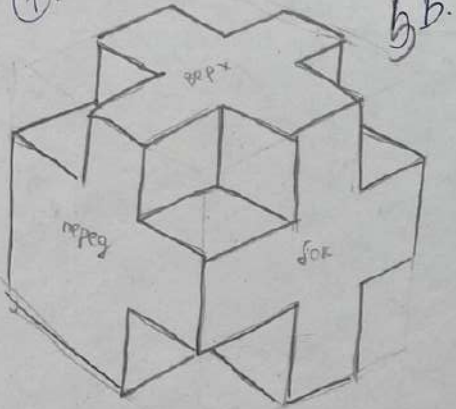

З.Б.

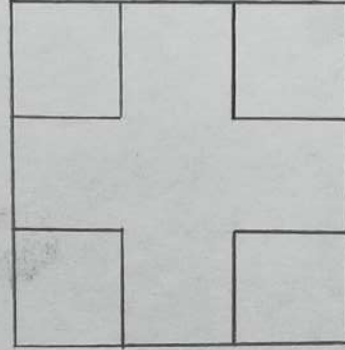

2

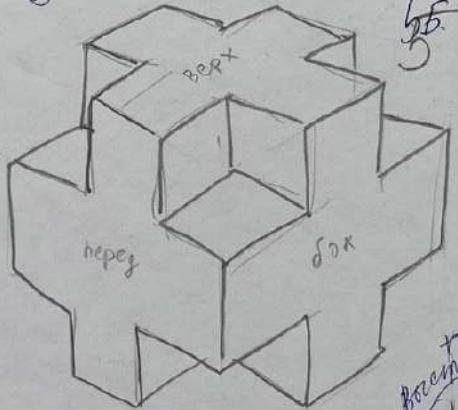

З.Б.

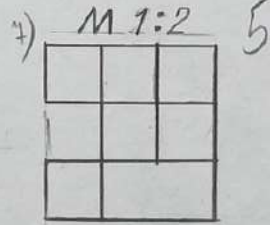

3)

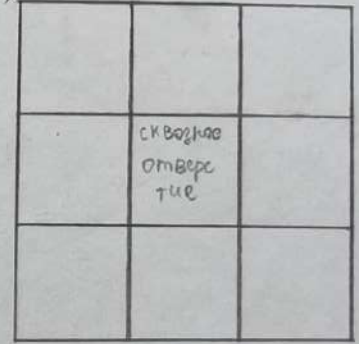

З.Б.

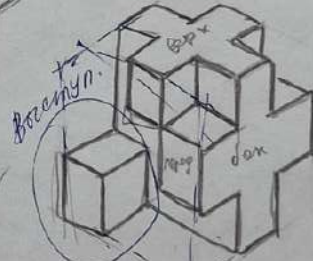
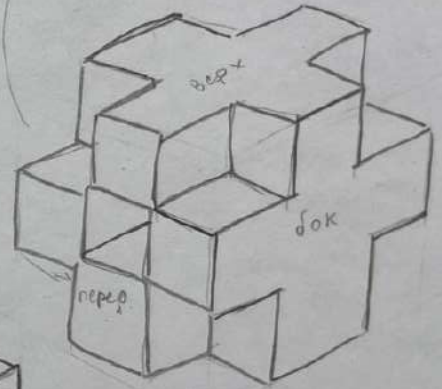

6)

З.Б.

5)

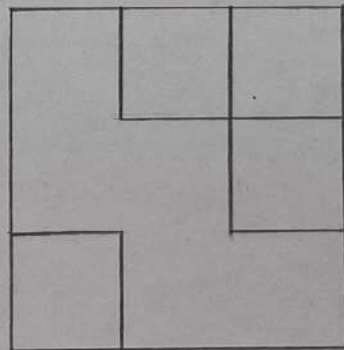

З.Б.

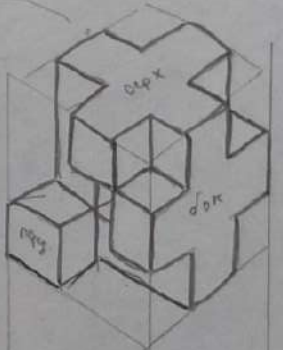

З.Б.

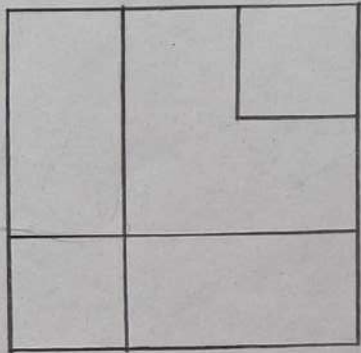

СКВОЗНО
ПРОБЕЖАЕТ

Возможн.

СКВОЗНО
ПРОБЕЖАЕТ

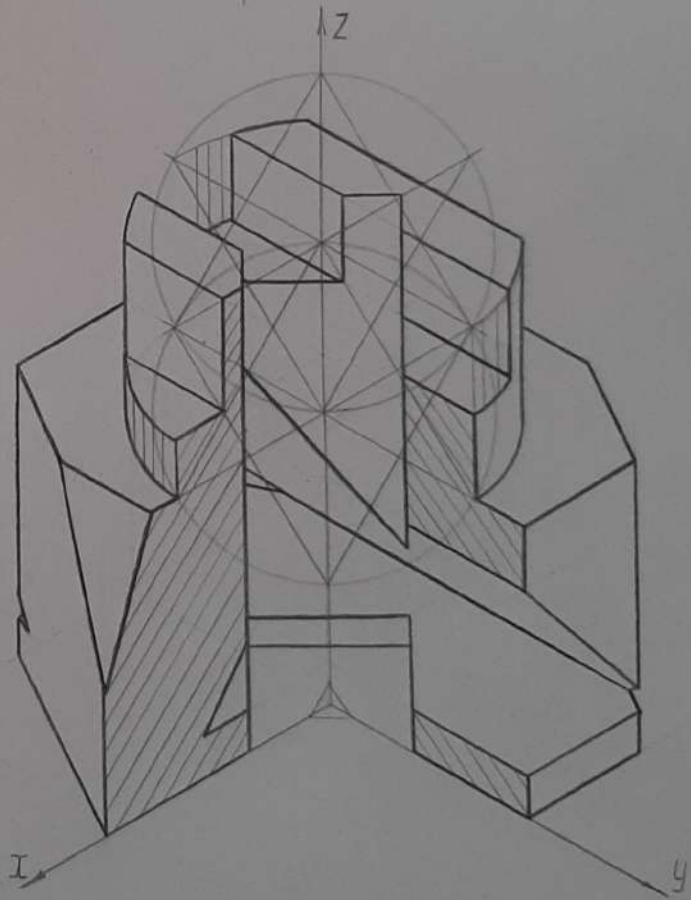
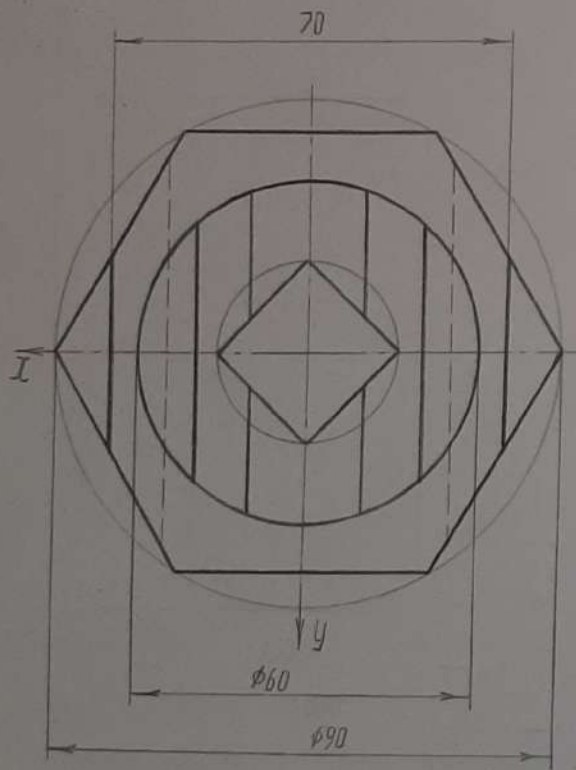
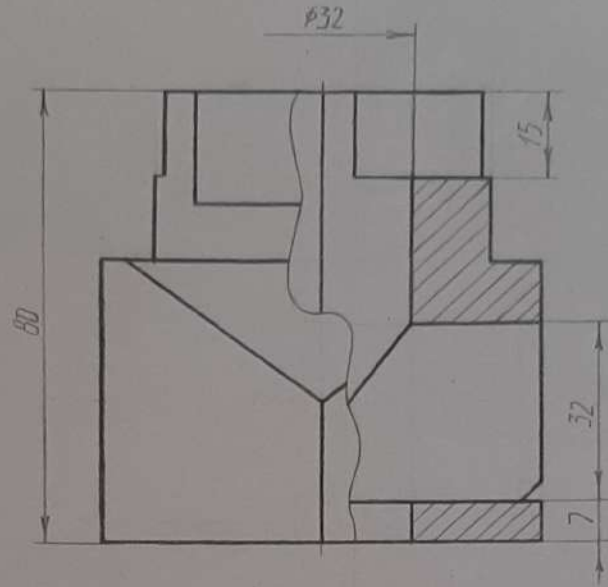
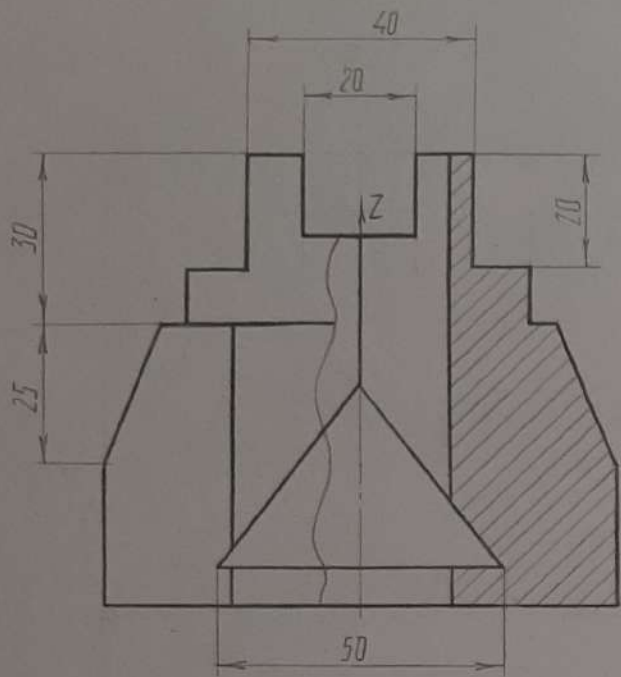

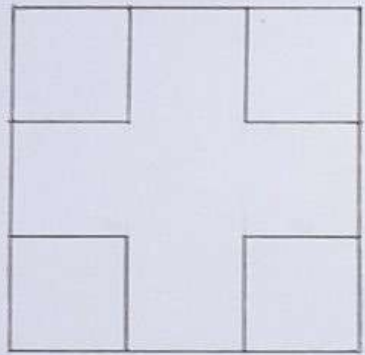

1

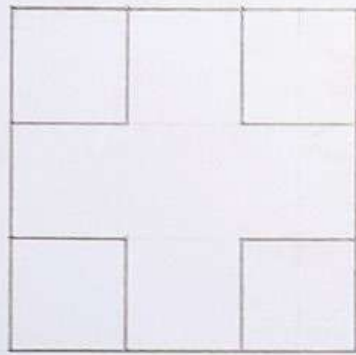

2

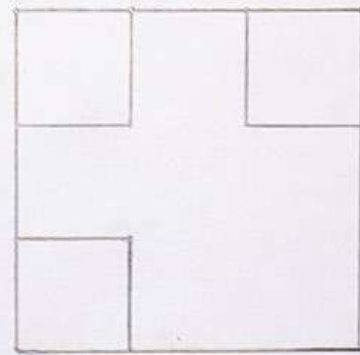

3

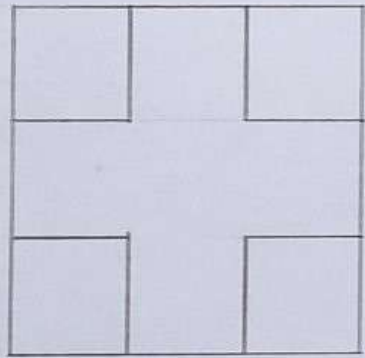
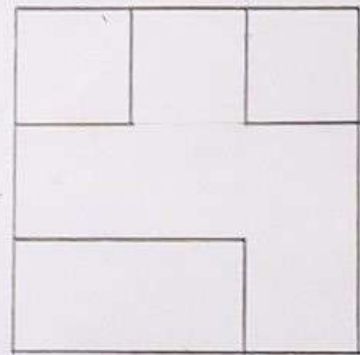

4

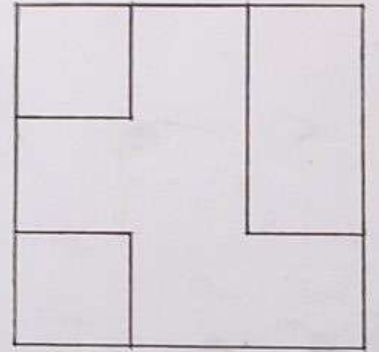

1

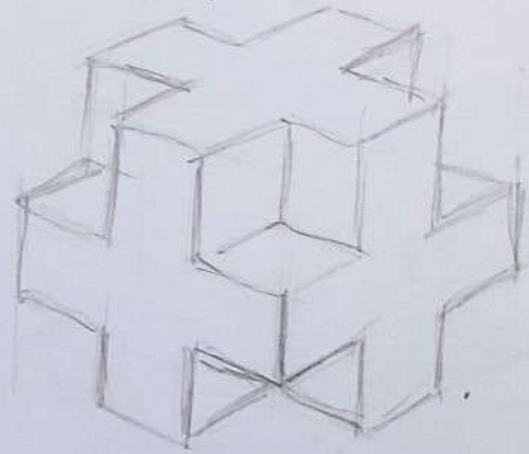

3

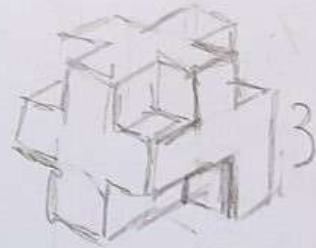

2

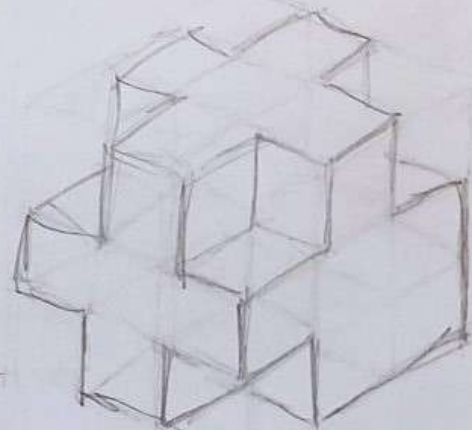

4

